

Article number: 20343260M1280KR
Description: E+G Levelling foot
GN 343.2-60-M12-80-KR
Note: 0

Measures

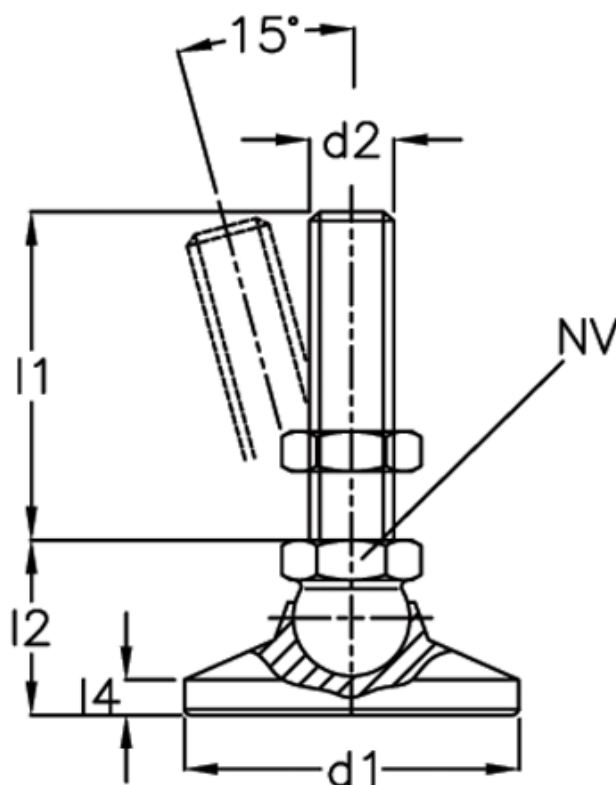

d1 = 60
d2 = M12
l1 = 80
l2 = -
l3 = 37.5
l4 = -
l5 = 10
NV = 17

Static load = 30
Weight in (g) = 465